

PowerCharge™

PRO LIGHTNING

CHARGING STATION

OPEN ACCESS | RFID ACCESS CONTROL | NETWORKED

Installation & User Manual



PowerCharge™, a Moser Services Group, LLC Company

500 Canal View Blvd, Suite 100, Rochester, NY 14623 | 585•533•4085 | PowerChargeEV.com

IMPORTANT SAFETY INSTRUCTIONS

This document contains instructions and warnings that must be followed when installing and using the Electric Vehicle Supply Equipment (EVSE). Before installing or using the EVSE, read this entire document paying special attention to all WARNINGS and CAUTIONS.

The symbols used have the following meaning:



WARNING: RISK OF PERSONAL INJURY



WARNING: RISK OF ELECTRIC SHOCK



WARNING: RISK OF FIRE



CAUTION: RISK OF DAMAGE TO THE EQUIPMENT

- The charging station power supply must only be installed by licensed electricians.
- Make sure that the materials used and the installation procedures both follow local building codes and safety standards.
- The information provided in this manual in no way exempts the user of responsibility from following all applicable codes or safety standards.
- This document provides instructions for the charging station and should not be used for any other product. Before installation or use of this product, review this manual carefully and consult with a licensed contractor, licensed electrician, or trained installation expert to make sure of compliance with local building codes and safety standards.

Repair and Maintenance Clause

- Only licensed electricians can repair or maintain the charging station. It is forbidden for general users to repair or maintain it.
- Disconnect all power before repair or maintenance of the charging station.

FCC Declaration of Conformity

- This charging station complies with part 15 of the FCC Rules. Changes or modifications to the charging station not expressly approved by the manufacturer could void FCC compliance.
- Operation is subject to the following two conditions: (1) this charging station may not cause harmful interference, and (2) this device must accept any interference received, including interference that may cause undesired operation.



WARNING: RISK OF ELECTRIC SHOCK

Basic precautions should always be followed when using electrical products, including the following:

- Read all the instructions before using this product.
- This device should be supervised when used around children.
- Do not put fingers into the electric vehicle (EV) connector.
- Do not use this product if the flexible power cord or electric vehicle (EV) cable is frayed, has broken insulation, or has other signs of damage.
- Do not use this product if the outer case or the electric vehicle (EV) connector is broken, cracked, open, or shows any other indication of damage.



WARNING: RISK OF ELECTRIC SHOCK

Improper connection of the equipment grounding conductor can result in a risk of electric shock. Check with a qualified electrician or serviceman if you are in doubt as to whether the product is properly grounded.



WARNING: RISK OF ELECTRIC SHOCK

- Do not touch live electrical parts.
- Incorrect connections may cause electric shock.



WARNING: This equipment is intended only for charging vehicles that do not require ventilation during charging. Please refer to your vehicle's owner's manual to determine ventilation requirements.



WARNING: Do not use extender cables to increase the length of the charging cable. Maximum length is limited to 25 feet as regulated by the National Fire Protection Agency.



WARNING: Do not drag the charging point by the input power cord.

SAVE THESE INSTRUCTIONS

Contents

- 1 Introduction 5
- 1.1 Product view 5
- 1.2 Box Contents 6
- 2 Installation 7
- 2.1 Before installation 7
 - 2.1.1 Safety check 7
 - 2.1.2 Grounding instructions 7
- 2.2 Tools & parts required for installation 8
- 2.3 Installation Readiness 8
 - 2.3.1 Grounding Instructions Reminder 9
- 2.4 Adjusting the Charging Station Maximum Current Output Setting (Optional) 9
- 2.5 Input Power Connection 11
- 2.6 Install the Charge Station 12
- 3 Specifications 14
- 3.1 Product Specifications 14
- 3.2 Waterproof Connector Specifications 15
- 4 Operations 17
- 4.1 Charging Status Indicators 17
- 4.2 Charging your Electric Vehicle (EV) 18
 - 4.2.1 Connect and Charge 18
 - 4.2.2 Stop Charging 18
 - 4.2.3 Auto Restart 18
 - 4.2.4 Power Outage Recovery 19
- 4.3 General Product Care 19
- 5 Customer Support 19
- 6 Limited Warranty 20
- 7 PowerCharge™ Pro-lightning Base Template 23

1. INTRODUCTION

This user manual applies to PowerCharge™ Pro-Lightning Series Level 2 AC Charging Stations for Plug-in Electric Vehicles (PEVs) and Battery Electric Vehicles (BEVs).

WARNING: Any unauthorized modifications will void the manufacturer's warranty and jeopardize safety of the user!

1.1 Product view

Different models of Charging Stations:

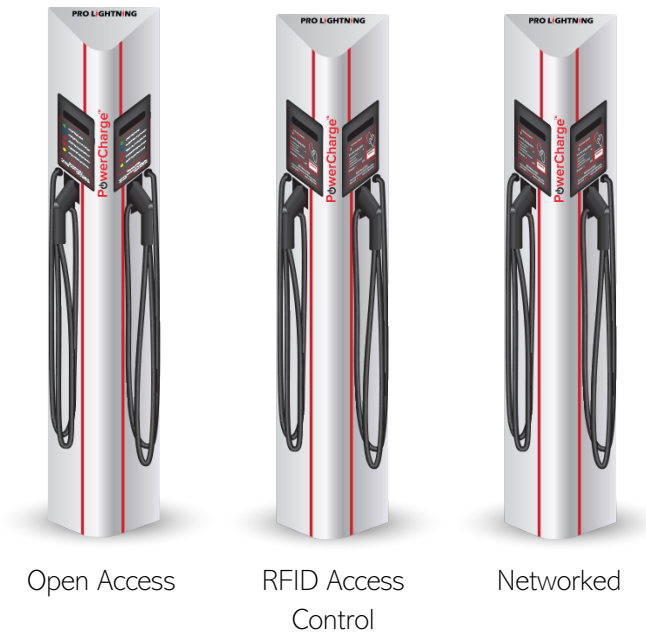

1.2 Box Contents



(1) Pre-Assembled PowerCharge™ Pro-Lightning Charging Station

(1) Hardware Kit:

QTY	Hardware
(3)	Drop-In Anchors
(3)	Anchor Bolts
(6)	50 AMP Wire Nuts (unless equipped with junction box)
(1)	T30 Torx Bit
(2)	¼ Drop-in Anchors
(2)	¼-20 x ¾ Stainless Screws
(2)	¼-20 Stainless Nuts

2. INSTALLATION

2.1 Before installation

2.1.1 Safety check



CAUTION: Disconnect the power supply before installing or repairing the charging station. Failure to do so may result in physical injury or damage to the power supply system and the charging station.



CAUTION: Avoid touching or pressing the OLED screen all times, as this may result in damage to the OLED screen.



DANGER: RISK OF SUFFOCATION

Keep any packing materials away from children – these materials are a potential source of danger, e.g., suffocation.

The charging station must be installed only by a licensed electrician in accordance with the provisions of the local electrical industry construction and should comply with national electrical codes and standards.

Before installing the charging station, make sure you have read all these instructions in this manual and fully understand its contents.

Appropriate protection is required when connecting to a power supply. The tools and parts in Section 2,2 shall be used.

2.1.2 Grounding Instructions

The charging station must implement equipment grounding through a permanent wiring system or an equipment grounding conductor. Use a wire with a dedicated grounding wire and a ring terminal. This wire should be connected to the equipment ground terminal block for grounding.

2.2 Tools & Parts Required for Installation

Tool	Model	Size	Supplier	Remark
Conduit – Flex Liquid Tight	All	Match stub-up conduit	Commercially Available	For power wires (may require adapter)
Conduit Connector	All	varies x ¾" NPT	Commercially Available	To connect conduit to junction box
Torx Screwdriver	All	T30 Bit	Included	For securement of side panels
Phillips Screwdriver	All	#2	Commercially Available	
Torque Wrench	All	¾" socket	Commercially Available	Base bolts to 90 to 100 FT-LBS
Copper Wire	All	8 AWG minimum (contractor must verify size for current size and run length)	Commercially Available	UL1015 (recommended)

2.3 Installation Readiness



WARNING: RISK OF ELECTRIC SHOCK

- Do not touch live electrical parts.
- Incorrect connections may cause electric shock.
- Disconnect the power supply to the charging station and verify no power is present before installing, adjusting, or repairing the charging station. Failure to do so may result in physical injury or damage to the power supply system and the charging station.

The charging station must be installed only by a licensed electrician in accordance with the provisions of the local electrical industry construction and should comply with national electrical codes and standards.

Before installing the charging station, make sure you have read these instructions in this manual and fully understand its contents.

Appropriate protection is required when connecting to a main panel/switchboard. The tools and parts used as outlined in the section "Tools & Parts Required for Installation".

Prior to mounting, locate an available electrical source that can support the following input requirements for the charging station per National Electric Code (NEC) requirements:

- Output setting set at factory. Check decal placed on the junction box to verify the factory setting.
- 32A Maximum Output Setting (Default Factory Setting): a DEDICATED CIRCUIT rated for 40A; 208-240 VAC, 50-60 Hz, Single Phase must be used. Circuits rated greater than 40A may also be used.
- Lower amperage setting optional. If a reduced setting is desired, contact the factory for technical support.
- The PowerCharge™ Pro-Lightning is available with single or dual power feed. This unit can only be wired as per decal instructions on the junction box. If equipped with optional single-circuit feed, it will be noted on decal placed on junction box.



CAUTION: The service wiring in this section is specific to North America only. Before installing the charging station, identify the type of utility service connection available onsite. If you are unsure about the type of connection available at the service panel, contact your utility service provider.

2.3.1 Grounding Instructions Reminder

The charging station must implement equipment grounding through a permanent wiring system or an equipment grounding conductor. Use a wire with a dedicated grounding wire and connect to the equipment ground terminal block for grounding.

2.4 Adjusting the Charging Station Maximum Current Output Setting (Optional)



WARNING: RISK OF ELECTRIC SHOCK

- Do not touch live electrical parts.
- Incorrect connections may cause electric shock.
- Disconnect the power supply to the charging station and verify no power is present before installing, adjusting, or repairing the charging station. Failure to do so may result in physical injury or damage to the power supply system and the charging station.
- Electrical Power **MUST** remain OFF and DISCONNECTED before setting or changing the DIP switch (if equipped). A non-conductive object **MUST** be used to adjust the DIP switch settings, failure to do so may result in risk of electrical shock and damage to the equipment.

The charging station product features the ability to adjust the maximum charging station current output to allow the use of a 40A (or greater), 30A, or 20A Dedicated Circuit per charge port as follows:

- 40A Circuit Rating: To support 32A (7.68 kW) maximum charging station output
- 30A Circuit Rating: To support 24A (5.76 kW) maximum charging station output
- 20A Circuit Rating: To support 16A (3.84 kW) maximum charging station output

The current (amperage) output is set at the factory. The charging station may require one or two feed(s). The default is to provide two (2) 208/240v, 40a circuit feeds. There is an optional single 208/240v, 40a feed (This option is available during the order process), The junction box will be labeled as such if this option has been configured. The charging station must be wired according to the diagram on the junction box (if equipped).

Using the included 50-amp outdoor rated wire nuts, connect the incoming wires to the charger wires in the junction box. Be sure to connect the L1, L2, and Ground wires accordingly. Each side of the charging station MUST receive its power from a common circuit breaker.

Once all wires are properly connected, tuck neatly into the junction box and replace the cover, making sure it has a tight seal.

2.5 Input Power Connection

1. Choose the appropriate conduit in accordance with all applicable state, local and national electrical codes and standards.
2. Connect copper wires with included 50 AMP wire nuts (if equipped).
3. Connect the circuit feed wires to the junction block in the junction box (if equipped).

3-1. Remove the junction box cover.

3-2. Connect input wiring conduit to junction box.

3-3. Connect the copper wires using the following:

White Wire	L1
Black Wire	L2
Green Wire	Ground

Model	Terminal	Conductor
PRO-LIGHTNING (PLXXXX)	L1, L2, G	8 AWG

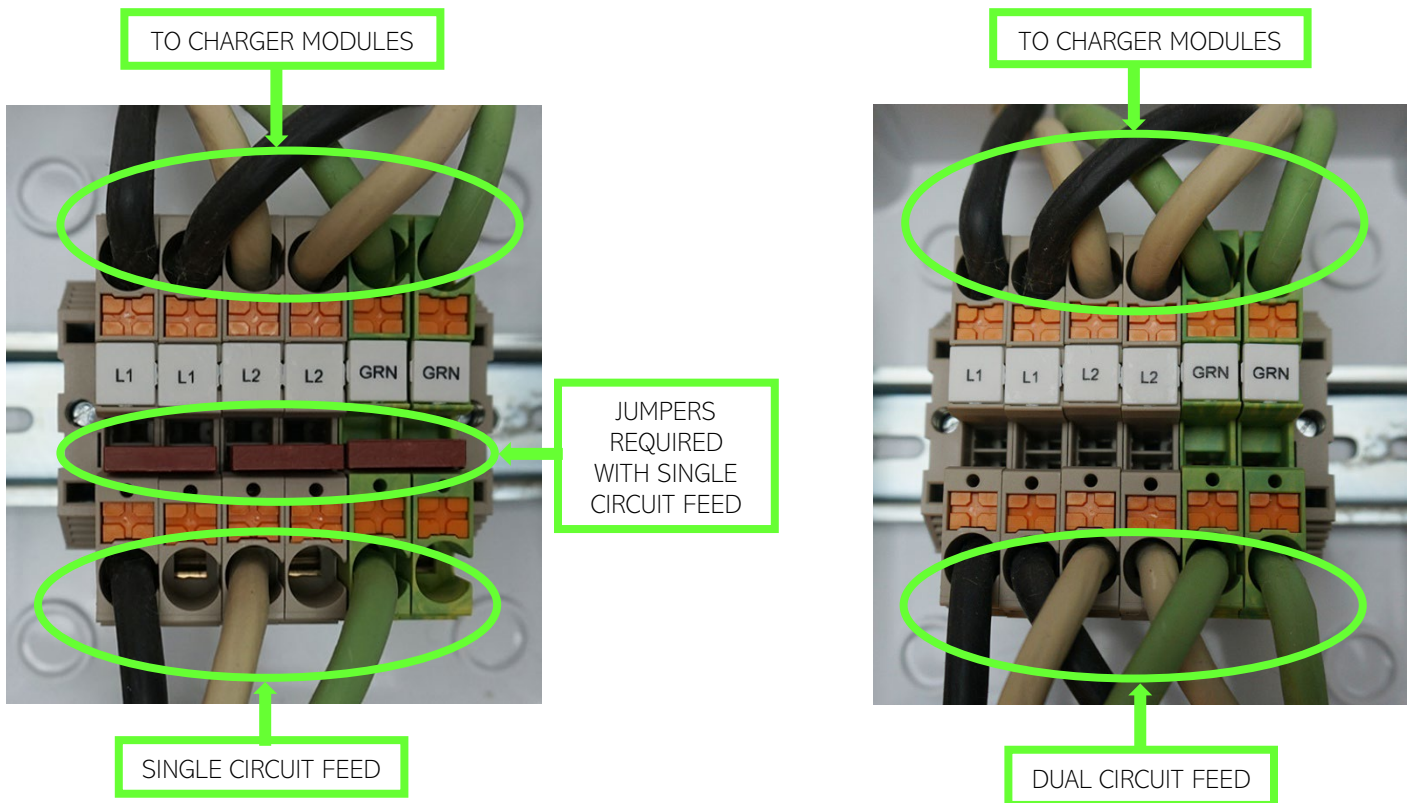



CAUTION: To reduce the risk of fire, connect only to a circuit provided with appropriate overcurrent protection in accordance with the National Electrical Code, ANSI/NFPA 70, and the Canadian Electrical Code, Part I, C22.1.



CAUTION: If this unit is installed outdoors, the outlet must be rated for outdoor installation. The outlet must be installed properly to maintain the proper NEMA rating of the enclosure.

2.6 Install the Charge Station

1. Secure main body to prepared charger base. To maintain ADA compliance, the charger base should be level with ground surface.

Follow applicable accessibility requirements for the mounting position. The unit shall be mounted at a sufficient height from ground such that the height of the storage means for the coupling device is located between 24 inches (600 mm) and 4 feet (1.2 m) from ground per NEC Article 625.

Charger base may be concrete (recommended 18" x 18" x 18" with conduit stub-up in center. Hollow composite-style base is also acceptable). Follow manufacturer installation instructions.

Mark the base bolt securement locations to position the charging station in the center of the base. If using a concrete base, drill 5/8" holes to accommodate, included drop-in anchors. If using a composite hollow base, use 1/2"x13 thread x 2" long stainless hex-head bolt with washer and nut.

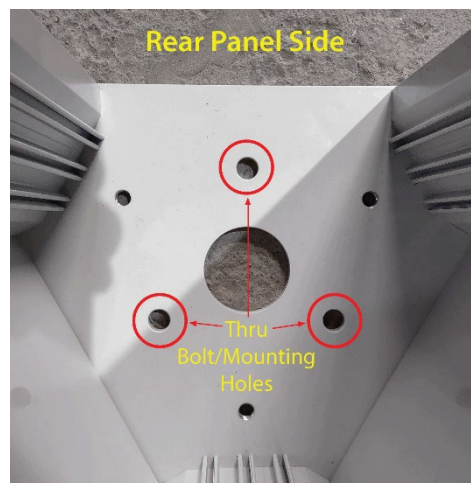

Base Mounting (Thru) Holes

***See last page for the Pro-Lightning Base Template

2. Level Charge Station.

Use the three leveling bolts to verify all three sides of the charging station are plumb.

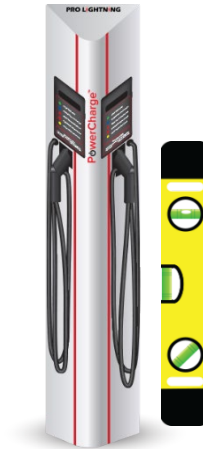
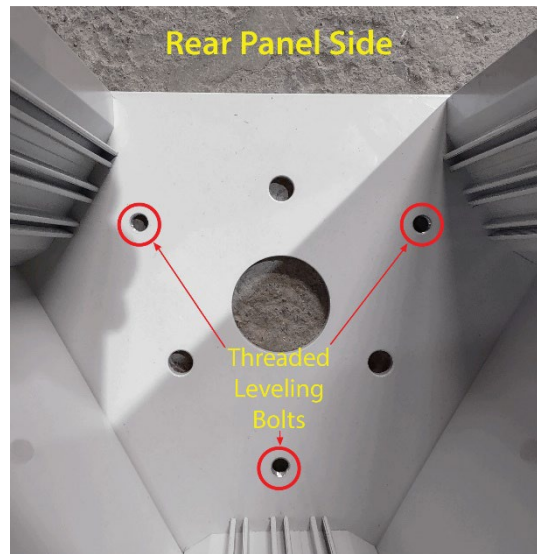

3. (OPTIONAL STEP) MOUNTING THE CABLE RETRACTOR

3a) Loosely attach rear panel to retractor using two ¼ - 20 x ¾ stainless screws, two ¼ - 20 stainless nuts and two ¼ inch nylon spacers.

3b) Dry fit the back panel and retractor combo to the back of the PL2 and loosely attach using the ¼ - 20 powder coated screws provided. Mark the ground to accept two ¼ inch drop-in anchors for the retractor base.

3c) Remove the back panel and retractor combo and drill and seat your anchor points.

3d) Secure back panel to retractor.

3e) Place the back panel and retractor combo into its final position on its anchors and secure to ground as well as securing the back panel to the Pro-Lightning.

4. SPECIFICATIONS

3.1 Product Specifications

CONFIGURATION ITEM	OPEN-ACCESS PLXXXX	RFID ACCESS CONTROL PLXXXXR	NETWORKED PLXXXXN
APPLICATION	Commercial		
VOLTAGE (VAC)	208/240VAC, Single Phase		
FREQUENCY (Hz)	60 Hz		
CURRENT (RMS)	Adjustable: 16A/24A/32A (3.8kW/5.8kW/7.6kW)		
CIRCUIT BREAKER	16A=20A/24A=30A/32A=40A		
CHARGING CONNECTOR	SAE J1772		
CHARGING CABLE LENGTH	18 ft.		
METERING ACCURACY	N/A	Embedded ± 3%	
REAL-TIME CLOCK	N/A	Yes (7 days)	
WI-FI	N/A	802.11 b/g/n	
CELLULAR	N/A	N/A	LTE / CDMA / GSM
RFID	N/A	ISO 14443 A/B ISO 15693 NFC NEMA interoperability protocol	
DISPLAY	Color LED Status Lights	116(L)*8.5(W)*37(H)mm, 5.57mm CHARACTER HEIGHT 5*8 DOT MATRIX OLED 20x2 Color LED Status Lights	
DATA PROTOCOL	N/A	OCPP 1.6	
OPERATION TEMPERATURE	-30C/-22F to 50C/122F		
STORAGE TEMPERATURE	-40C/-40F to 70C/158F		
MOUNTING TYPE	Pedestal Mount / Wall Mount		
WIRING TYPE	Hard-wired		
IP PERFORMANCE	NEMA 4		
DIMENSION (LxWxH, INCHES)	14.74 x 13.43 x 15.861		
WEB PORTAL MANAGEMENT	N/A	Yes	
CONSOLE MANAGEMENT	Yes		
CERTIFICATION	N/A	UL 50/991 / 1449/1998/2231/2594 FCC Part 15B	
	N/A	FCC Part 15.225 (RFID 13.56MHz) FCC Part 15.247 (WLAN 2.4GHz)	
	N/A	FCC Part 27 (AT&T) or FCC Part 27 (Verizon) Energy Star (#E354962)	
SAFETY CERTIFICATION	UL 354962		
PEDESTAL CONSTRUCTION	Aluminum, Grey Powder-Coat Finish, Stainless Steel Hardware		
WARRANTY	Housing - 10 year / Electronic Components - 3-Year (Component Exchange Program)		

PRO-LIGHTNING SERIES MODEL NUMBERS

PowerCharge Pro-Lighting
PL (10/15/20) (D/S) (P/W) (N/R/) - (CR/)

Ex: PL20DPN-CR = Pro-Lighting Series,
20 MRPH (32 Amp), Dual Connector,
Pedestal Mount, Networked,
Cable Retractor

	CONSTANT	VARIABLE	OPTIONS
PL		MRPH (Miles of Range Per Hour of Charge)	10 miles / 16 Amp 15 miles / 24 Amp 20 miles / 32 Amp
PL		Connectors	D - Dual S - Single
PL		Mount	P - Pedestal W - Wall Mount
PL		Configuration	N - Networked R - RFID Access () - Open Access
PL		Cable Retractor	CR - Cable Retractor () - No Cable Retractor

3.2 Waterproof Connector Specifications



DRYCONN[®]
WATERPROOF CONNECTORS

Filled Connectors for Outdoor/Electrical Use



INSTALLATION INSTRUCTIONS

IMPORTANT: Turn off power before installing or removing connector. Product to be used in accordance with local and national codes.

- Strip wires 3/4" (19.1mm).
- Align any frayed strands or conductors.
- Pre-twisting unnecessary. Place stripped wires together with ends of insulation even.
- Twist connector onto wires pushing firmly until hand-tight. Do not over torque.
- Wipe sealant in and around conductors and connector opening while tightening. Do not reuse.

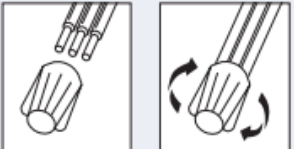

Large Waterproof Connectors

Catalog #	Selling Unit
62310	Card of 3
62325	Bag of 15
62335	Bag of 50
62340	Bag of 250

PRODUCT SPECIFICATIONS & MEASUREMENTS

Max. Voltage: 600V max. building wire (1000V max. signs or luminaires)
 Connector Size: 1 1/4" x 13/16"
 Wire Type: Copper/Copper
 Wire Range: Min #14/Max #6
 Temperature Rating: 105°C (221°F)
 Silicone Sealant Temperature: -45°F to 400°F
 UL Designation: LWP*

Measurements (Inches):

A - 1.64
 B - 0.82
 C - 0.63

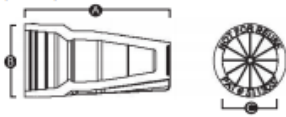



UL Listed as a Sealed Wire Connector. For use in dry, damp, wet locations below or above grade when used in an enclosure. For use in direct bury applications when operating at 30 volts or less.

NEC Required for Outdoor Connections

Selected 600V Wire Combinations
 For use with solid and/or stranded combinations.

2 #8	1 #10 w/3-5 #14	3 #10 w/1-2 #18
2-3 #10	2 #10 w/1-2 #12	4 #12 w/1 #14
3-5 #12	2 #10 w/1-3 #14	1 #10 w/2-3 #12
3 #10 w/1 #14		

Contact factory for a complete list of wire combinations at 800.633.0232.



50100-02 REV J 08/18



MADE IN USA
 www.kinginnovation.com
 (P) 800.633.0232
 (F) 636.519.5410

TEMPERATURE RATING: 105°C (221°F) SILICONE SEALANT TEMPERATURE: -45°F TO 400°F
APPLICATION: 600V maximum building wire; 1000V maximum signs or luminaires. Copper to Copper only. UL listed as a Sealed Wire Connector. For use in dry, damp, wet locations below or above grade when used in an enclosure. For use in direct bury applications when operating at 30 volts or less.









INSTALLATION INSTRUCTIONS: Important: Turn off power before installing or removing connector. Product to be used in accordance with local and national codes.

1. Strip wires 3/4" (19.1mm).
2. Align any frayed strands or conductors.
3. Pre-twisting unnecessary, Place stripped wires together with ends of insulation even.
4. Twist connector onto wires pushing firmly until hand-tight. Do not over torque.
5. Wipe sealant in and around conductors and connector opening while tightening, Do not reuse.

4. OPERATIONS

4.1 Charging Status Indicators

(Applicable to Open Access Charger only)

LED Indicator	Description	Definition
	Not illuminated	Power Off
	Green Steady	Ready
	Green Flashing	Flashing green (Fast): Authorized, wait for EV Connect Flashing green (Slow): Suspend (Occupying)
	Blue Flashing	Flashing blue (Slow): Charging
	Red Steady	Unrecoverable Fault
	Red Flashing	Recoverable Fault
	Yellow Steady	Out of Service
	Yellow Flashing	Booting / Firmware Upgrading

4.2 Charging your Electric Vehicle (EV)

4.2.1 Connect and Charge

1. Insert the charging connector into the vehicle (*note: will auto-start with Open Access Control models only*).
2. Turn on with app (networked models) or RFID card (networked and RFID Access Control models).
3. Wait for authorizing.
4. Begin charging session.



Connect the Charging Plug to the Vehicle

4.2.2 Stop Charging

1. Unplug at any time (disconnect the charging plug from the vehicle to stop charging session).
2. Session ended (please return the connector to the holster).

4.2.3 Auto Restart

When a charging session is interrupted due to a temporary error condition, the charging station will automatically restart charging when the cause of the temporary error condition returns to normal. The status indicator lights remain flashing RED until the error condition is resolved.

- Temporary error conditions include: Over Current, Over Voltage, Under Voltage, and Over Temperature.
- For Over Current (OC) conditions: The charging session will be stopped while OC occurs. After recovery from OC for 30 seconds, the charging station will automatically restart charging for three times.
- When charging session stopped due to CCID trip, the charging station will try to restart after 15 minutes for 3 times.

4.2.4 Power Outage Recovery

When power resumes after an outage, the charging station restarts automatically with a delay ranging from 120 to 720 seconds. The delay is designed to avoid impacting the utility grid when multiple charging stations are in the same area attempting to resume charging simultaneously.

4.3 General Product Care

The exterior of the charging station is designed to be waterproof and dust proof. To ensure proper maintenance of the charging station, follow these guidelines:

- Despite the water resistance of the enclosure, when cleaning it is preferred to not direct streams of water at the unit. Clean with a soft damp cloth.
- To avoid damage to the charging plug, make certain it is put back in the holster after charging.
- To avoid damage to the power cable, make sure it is stored on the cable holster after use.
- If the power cable or the charging plug is damaged, please contact PowerCharge™ Support.

5. CUSTOMER SUPPORT

If the charging station is not operational or you need assistance, please contact:

PowerCharge™
500 Canal View Blvd, Suite 100
Rochester, NY 14623

585 • 533 • 4085

www.PowerChargeEV.com

Hours: Mon-Fri, 8am to 5pm, *Eastern Time*

6. LIMITED WARRANTY

Limited Warranty for PowerCharge™ Pro-Lightning Series Electric Vehicle Charging Station

- PowerCharge™ Electric Vehicle Charging Station is warranted against defects in materials and workmanship for three (3) years from date of purchase for the electronics and ten (10) years from the date of purchase for the housing and optional cable retractor system.
- Cables, J1772 Connectors and retractor rope are wear items and warranted against defects in materials and workmanship for ninety (90) days from purchase.

IMPORTANT: It is the Purchaser's obligation to register the Charging Station with PowerCharge™ and failure to do so may delay warranty support. This warranty is only valid to the original purchaser of the Electric Vehicle Charging Station and is not transferrable. ALL WARRANTY CLAIMS MUST BE MADE WITHIN THE WARRANTY PERIOD AND PROOF OF PRODUCT PURCHASE AND WARRANTY REGISTRATION NUMBER MUST BE SUPPLIED. This warranty does not cover labor or the cost of freight to return the Electric Vehicle Charging Station to PowerCharge™.

Registration: Please complete and return the accompanying Warranty Registration Card to:
PowerCharge™, 7464 W. Henrietta Rd., Rush, NY 14543
or email the product registration information to warranty@PowerChargeEv.com.

Subject to the exclusions from the Warranty coverage set forth below, PowerCharge™ warrants that, when used under normal operating conditions, your Charging Station will be free from any defects in materials or workmanship for a period (the "Warranty Period") of three (3) or ten (10) years from the date of original purchase, based on the area of the defect. If, during the Warranty Period, your Charging Station becomes defective in breach of the Warranty, PowerCharge™ will, upon written notice of the defect received during the Warranty Period, either repair or replace, at PowerCharge's election, the Charging Station. The Warranty covers both parts and labor necessary to repair your Charging Station but does not include any on-site labor costs related to un-installing or reinstalling the repaired or replacement Charging Station or any component. Any replacement Charging Station or component so furnished will be warranted for the remainder of the original Warranty Period.

Steps to Obtain Warranty Service

- 1) If at any time during the term of your Warranty you believe you have a defective Charging Station, contact customer service at 1.585.533.4085 or warranty@PowerChargeev.com and request a Return Material Authorization ("RMA") number from PowerCharge™.
- 2) In connection with your RMA request, you will be asked for each of the following:
 - a. A detailed description of the problem(s) you are experiencing with the Charging Station
 - b. The model number and serial Number of the Charging Station
 - c. Proof of Purchase and Warranty Registration Number
 - d. Return Shipping Information
- 3) If PowerCharge™ determines that the defect appears to be covered by your Warranty and your Warranty is still in effect, you will be provided a Returned Material Authorization Number (RMA number) to reference when returning the defective Charging Station for repair or replacement.
- 4) Ship the defective Charging Station to PowerCharge™ and reference the RMA number in the shipping documentation. The Charging Station must be returned in its original shipping container or in another shipping container designed to prevent damage to the Charging Station.
- 5) If your Charging Station is covered by Warranty, PowerCharge™ will either repair or replace the defective Charging Station or failed component at no charge to you and ship the repaired or replaced Charging Station back to you at PowerCharge's expense.

IMPORTANT:

- 1) You are responsible for the proper installation and maintenance of the Charging Station including the un-installing of any defective Charging Station or component and the installation of a repaired or replacement Charging Station or component returned to you. Installation and uninstallation shall be performed only by a qualified electrician.
- 2) Any service or repairs beyond the scope of the Warranty above will be performed upon customer approval at PowerCharge™'s then prevailing labor rates and other applicable charges.
- 3) Any Charging Station that is found by PowerCharge™ to be out-of-warranty or otherwise ineligible for warranty services will be returned, repaired, or replaced upon customer approval at PowerCharge™'s standard charges at the customer's expense.
- 4) Please read carefully through the detailed descriptions of the WARRANTY, the EXCLUSIONS FROM WARRANTY, and the DISCLAIMER AND LIMITATION OF LIABILITY listed below to assure that your Charging Station is eligible for warranty service without additional cost to you.

Replacement Parts or Charging Stations

You acknowledge that replacement parts or Charging Stations provided by PowerCharge™ under the Warranty may be remanufactured or reconditioned parts or Charging Stations. All replaced parts, whether under warranty or not, become the property of PowerCharge™. Any replacement parts or Charging Stations so furnished will be warranted for the remainder of the original Warranty Period.

Exclusions from Warranty

IMPORTANT: The Warranty on your Charging Station shall not apply to defects or service repairs resulting from the following:

- Improper site preparation or maintenance, improper installation, cosmetic damage such as scratches and dents or normal aging.
- Abuse, vandalism, damage, or other problems caused by accidents, misuse, or negligence (including but not limited to physical damage from being struck by a vehicle) or use of the Charging Station in a way other than is specified in the applicable PowerCharge™ documentation.
- Installation, alteration, disassembly, modification, or relocation of the Charging Station that was not approved in writing by PowerCharge™ or performed by PowerCharge™ or by a certified installer or service provider.
- Damage to the Charging Station caused by software, interfacing, parts, supplies or any other product not supplied by PowerCharge™.
- Damage as the result of extreme power surge, extreme electromagnetic field, or any acts of nature.
- Any other causes beyond the control of PowerCharge™.

Disclaimer and Limitation of Liability

NO AGENT OF PowerCharge™ IS AUTHORIZED TO ALTER OR EXCEED THE WARRANTY OBLIGATIONS OF PowerCharge™. THE REMEDIES IN THIS LIMITED PRODUCT WARRANTY ARE YOUR SOLE AND EXCLUSIVE REMEDIES. TO THE EXTENT PERMITTED BY APPLICABLE LAW AND EXCEPT AS EXPRESSLY PROVIDED IN THE LIMITED WARRANTY, PowerCharge™ MAKES NO WARRANTY WITH RESPECT TO THE CHARGING STATION, WHETHER EXPRESS, IMPLIED, STATUTORY OR OTHERWISE.

PowerCharge™ EXPRESSLY DISCLAIMS ALL OTHER WARRANTIES, INCLUDING, BUT NOT LIMITED TO, THE IMPLIED WARRANTIES OF NON-INFRINGEMENT OF THIRD-PARTY RIGHTS, MERCHANTABILITY AND FITNESS FOR A PARTICULAR PURPOSE. PowerCharge™ DOES NOT WARRANT UNINTERRUPTED OR ERROR FREE OPERATION OF THE CHARGING STATION.

PowerCharge™ IS NOT LIABLE FOR ANY INDIRECT, INCIDENTAL, SPECIAL, PUNITIVE OR CONSEQUENTIAL DAMAGES, INCLUDING WITHOUT LIMITATION LOST PROFITS, LOST BUSINESS, LOST DATA, LOSS OF USE, OR COST OF COVER INCURRED BY YOU ARISING OUT OF OR RELATED TO YOUR PURCHASE OR USE OF, OR INABILITY TO USE, THE CHARGING STATION, UNDER ANY THEORY OF LIABILITY, WHETHER IN AN ACTION IN CONTRACT, STRICT LIABILITY, TORT (INCLUDING NEGLIGENCE) OR OTHER LEGAL OR EQUITABLE THEORY, EVEN IF PowerCharge™ KNEW OR SHOULD HAVE KNOWN OF THE POSSIBILITY OF SUCH DAMAGES. IN ANY EVENT, THE CUMULATIVE LIABILITY OF PowerCharge™ FOR ALL CLAIMS WHATSOEVER RELATED TO THE CHARGING STATION WILL NOT EXCEED THE PRICE YOU PAID FOR THE CHARGING STATION. THE LIMITATIONS SET FORTH HEREIN ARE INTENDED TO LIMIT THE LIABILITY OF PowerCharge™ AND SHALL APPLY NOTWITHSTANDING ANY FAILURE OF ESSENTIAL PURPOSE OF ANY LIMITED REMEDY.

Some states do not allow for the exclusion or limitation of incidental or consequential damages for some products, so the limitations or exclusions contained herein may not apply to you.

This Warranty is the entire and exclusive agreement between you and PowerCharge™ with respect to its subject matter, and any modification or waiver or any provision of this statement is not effective unless expressly set forth in writing by an authorized representative of PowerCharge™.

 PRODUCT WARRANTY REGISTRATION CARD	
Please complete and return to: PowerCharge™ 500 Canal View Blvd, Suite 100, Rochester, NY 14623 or email to: Warranty@PowerChargeEV.com	
Product Model No:	Date Purchased:
Serial No:	Where Purchased:
Print Name:	
Address:	
Email Address:	Phone Number:
<i>My Signature below acknowledges that I have read, fully understand and accept the Terms and Conditions stated on the PowerCharge Energy Series Electric Vehicle Charging Station Limited Warranty.</i>	
Signature:	Date:
** Must return within 30 days of Actual Purchase **	

FRONT

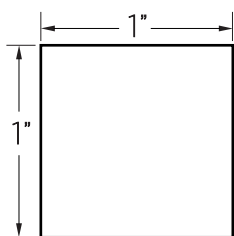
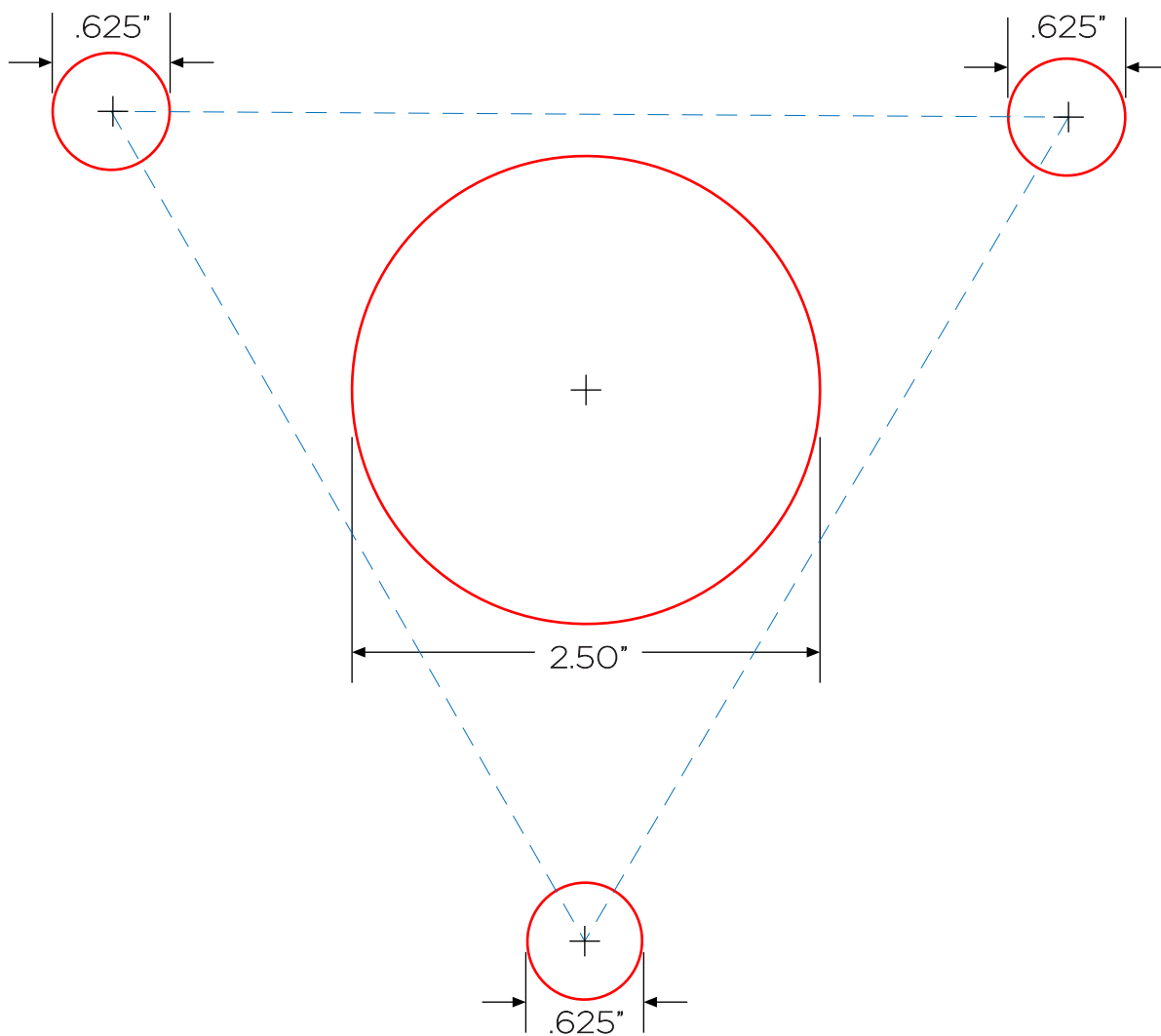

PRINT INSTRUCTIONS:

- PAPER SIZE: 8.5 x 11"
- SET PRINT TO "DO NOT SCALE" / "ACTUAL SIZE"
- CHECK PRINT TO ENSURE CORRECT SCALE